

SPH 鋼製手動泵浦

- 內含安全閥設計避免超壓引起損壞。
- 油箱容量大，適用範圍廣泛。
- 雙速操作、自動切換、省力有效率。
- 絕緣把手維護使用者安全。

Steel Hand Pump

- ※ Internal pressure relief valve for overload protection.
- ※ Large oil capacity, suitable for wide application.
- ※ Two speed auto-switch reduces manpower and increase efficiency.
- ※ Non-conductive fiberglass handle for operator safety.



其他選配說明

假如您需加裝4口方向閥來操作雙動油壓缸，請依下列規範字尾增加編號。

加裝4口方向閥：型號D

案例：
SPH-2000 選配4口方向閥，訂購型號改為 SPH-2000D
相關技術諮詢請與SUN RUN取得聯繫。

Optional Features

To add optional features to your pump, add the follow suffixes to the end of the model number.

4 ways control Valve : Model D

Example :

SPH-2000 with 4 ways control valve, order: SPH-2000D. Technical specifications for these features are available from SUN RUN.

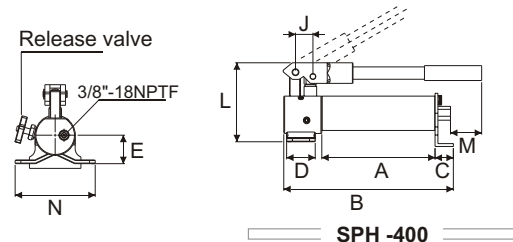

SPH-400



SPH-400

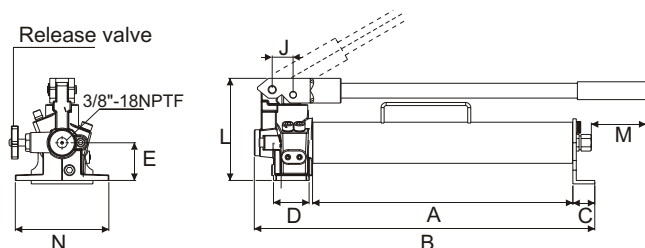

SPH-900

SPH-2000



SPH-900

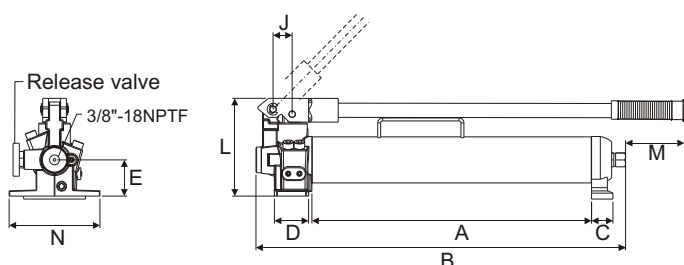

SPH-1200



SPH-1200

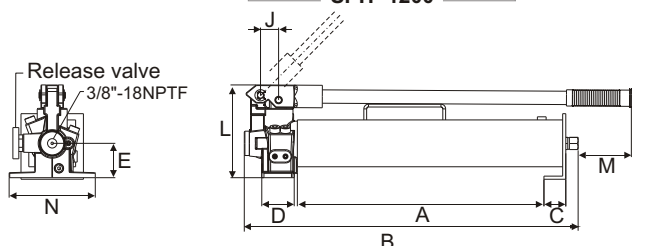

SPH-3000



SPH-3000

型號 Model Number	泵浦類型 Pump Type	有效油量 Usable Oil Capacity (cm ³)	輸出壓力 Pressure Rating (bar)		輸出油量 Oil Displacement per Stroke (cm ³)		行程 Piston Stroke (mm)	外型尺寸 Dimensions(mm)								重量 (含油) Weight (include oil) (kg)	
			1 st stage	2 nd stage	1 st stage	2 nd stage		A	B	C	D	E	J	L	M		N
			(bar)		(cm ³)												
SPH-400	單速 S/S	400	—	700	—	1.25	22	190	292	34.0	50	50	31	139	57	140	5.0
SPH-900	雙速 Two-Speed	900	14	700	12.5	2.8	21	395	514	34.0	45	55	31	150	67	136	7.5
SPH-1200		1200	14	700	12.5	2.8	19	425	536	32.5	48	55	29	150	65	137	9.0
SPH-2000		2200	14	700	14.5	2.8	21	425	536	32.5	45	55	29	150	60	136	10.5
SPH-3000		3000	14	700	14.5	2.8	21	425	562	45.0	48	55	29	150	65	137	13.6

SPHW 手動水壓/油壓泵浦

- 手動操作泵浦，操作液體可為"水"，壓力可達700bar。
- 不銹鋼材質及特殊防鏽處理。
- 亦可操作油液為媒介。
- 如同其他經過長時間測試的700bar系列泵浦；安全無虞。
- 高-低壓自動切換泵浦；增加工作效率。



Water/ Hydraulic Manual Pump

- ※ Manual pump whose hydraulic fluid is "water" and can increase the pressure up to 700bar.
- ※ Special rust-proof treatment is performed to the stainless-steel materials or special steel where the pump contacts water.
- ※ Can be used in a place where the usage of oil is hesitated.
- ※ A safe mechanism incorporating a safety valve like other time-tested 700 bar series.
- ※ Automatic high-low pressure switching pump for improved work efficiency.

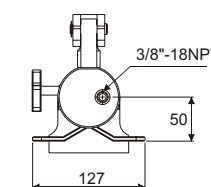
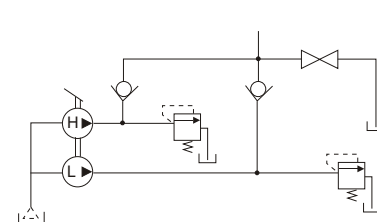

單位unit (mm)

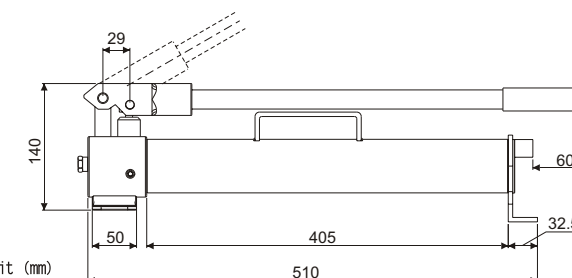

型號 Model Number	輸出壓力 Pressure Rating (psi)/(bar)	流量 Output flow rate (c.c/stroke)	水箱容量 Water capacity (c.c)	重量(無水) Weight (No water) (kg)
SPHW-900	10,000(700)	2.3	900	5.7

SPHP 手動油壓泵浦頭

- 可調式連結設計，可減少施力。
- 萬向泵浦頭便於安裝。
- 多款操作壓力可供選擇。
- 適用於空間限制或做為低壓高流量的備用手動油壓動力單元。
- 亦適用於當泵浦油箱需更換時。
- 把手材質為鋁合金，其長度 $\varnothing 22 * 600\text{mm}$ 。



Special Application Pump Head

- ※ Adjustable linkage for reduced handle force.
- ※ Swivel pump head for flexible fixturing.
- ※ Wide range of operating pressures to select from.
- ※ Design for tight mounting space, backup manual power or lower pressure and high flows.
- ※ Design for applications when pumps oil tank need to be changed.
- ※ SPHP and SPHH handle construct by Aluminum Alloy which dimension be $\varnothing 22 * 600\text{mm}$.

型號 Model No.	輸出壓力 Pressure Rating (psi)/(bar)	流量 Volume (c.c/stroke)	最大施力 Max. Handle Eff. (kgf)	重量 Weight (kg)
SPHP-50	750(50)	75	36	5
SPHP-70	1,000(70)	35	48	5
SPHP-210	3,000(210)	22	54	4
SPHP-450	6,500(450)	9	54	4
SPHP-700	10,000(700)	5	54	4

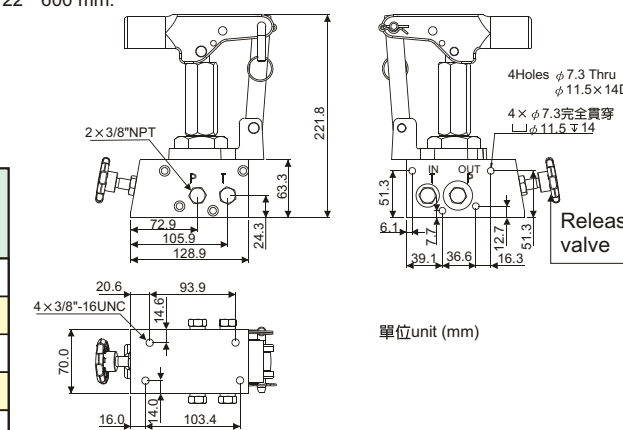

單位unit (mm)